

TYPE HOEKL075HAK

Afmetingen

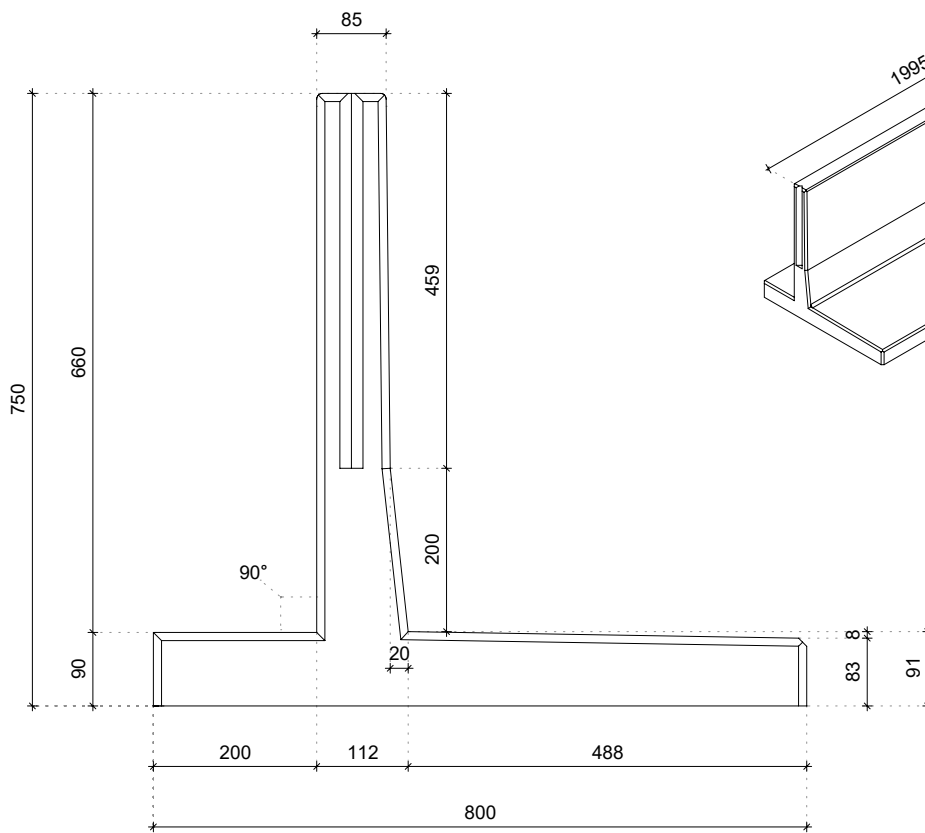

Details

Afgeronde bovenzijde

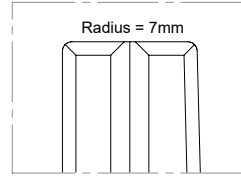

Koppellat-sparing

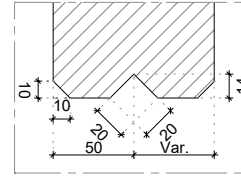

Verbinding elementen

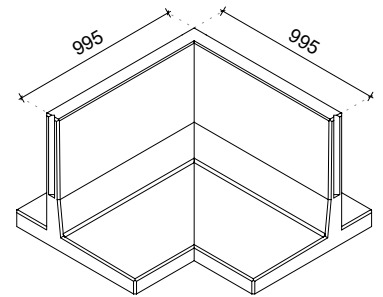
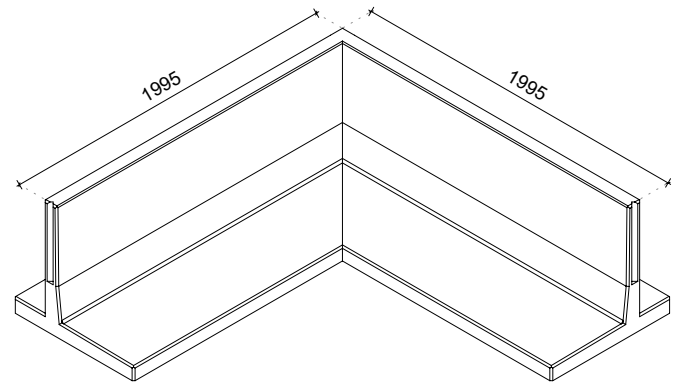
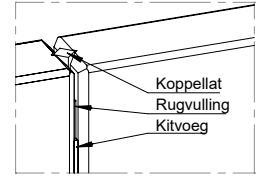

Technische details

Betonreceptuur 3rd generation self-compacting C55/67
Wapeningsstaal B500
Gewicht 1140kg (L = 1995x1995mm)
540kg (L = 995x995mm)

Betondekking 30mm
Maattolerantie +/- 5mm
Zichtbetonklasse Alle zichtzijdes glad bekist (klasse A)
Ontwerplevensduur 50 jaar
Productgarantie 10 jaar
Milieuklasse XA3, XC4, XD3, XS3, XF4
Hijsvoorziening Geen, plaatsen met klem

Geconstrueerd conform

NBN-EN 1990 Eurocode 0 NBN-EN 206
NBN-EN 1991 Eurocode 1 Incl. nationale bijlagen
NBN-EN 1992 Eurocode 2
NBN-EN 1997 Eurocode 7

Productiewijze



Energie
neutraal



Gefilterd
hemelwater



Duurzame
grondstoffen



Recyclebare
materialen

Certificering

