

TYPE L075

Afmetingen

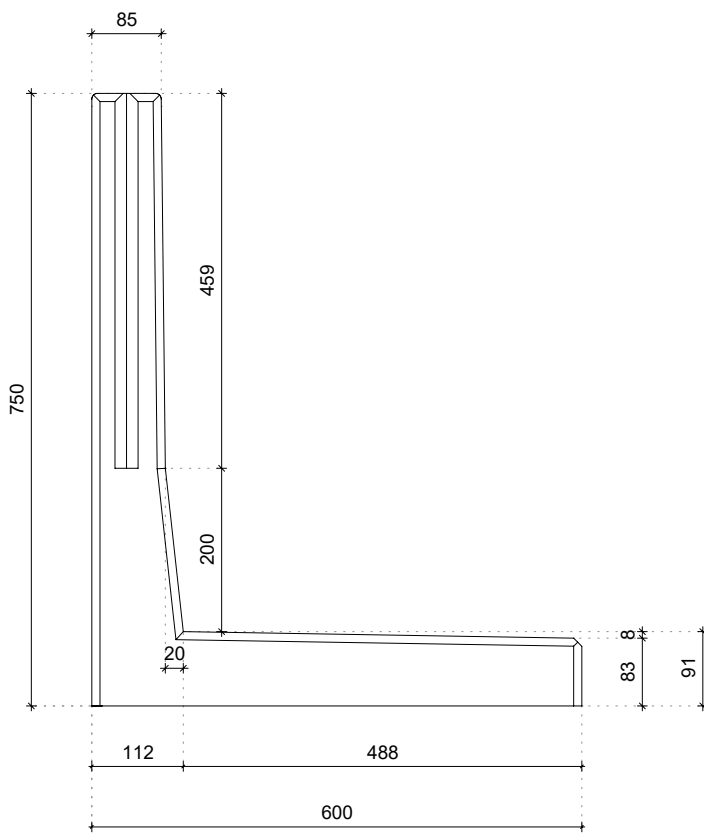

Details

Afgeronde bovenzijde

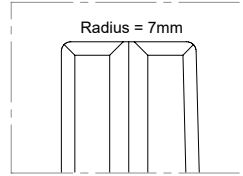

Koppellat-sparing

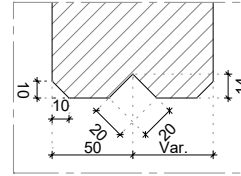

Verbinding elementen

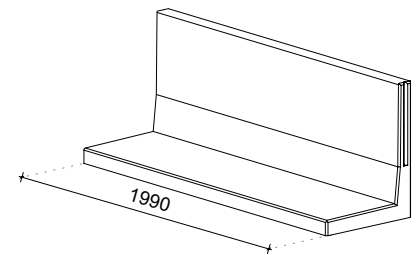
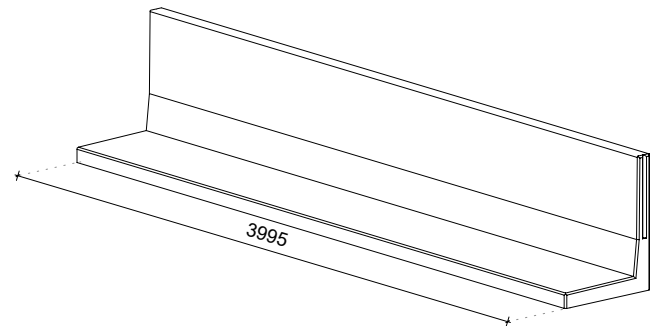
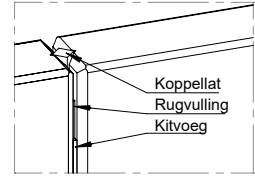

Technische details

Betonreceptuur	3 rd generation self-compacting C55/67
Wapeningsstaal	B500
Gewicht	1060kg (L = 3995mm) / 530kg (L = 1990mm)
Betondekking	30mm
Maattolerantie	+/- 5mm
Zichtbetonklasse	Alle zichtzijdes glad bekist (Klasse A)
Ontwerplevensduur	50 jaar
Productgarantie	10 jaar
Milieuklasse	XA3, XC4, XD3, XS3, XF4
Hijsvoorziening	Geen, plaatsen met klem

Geconstrueerd conform

NBN-EN 1990 Eurocode 0	NBN-EN 206
NBN-EN 1991 Eurocode 1	Incl. nationale bijlagen
NBN-EN 1992 Eurocode 2	
NBN-EN 1997 Eurocode 7	

Productiewijze



Energie
neutraal



Gefilterd
hemelwater



Duurzame
grondstoffen



Recyclebare
materialen

Certificering

