

LA300S

Afmetingen

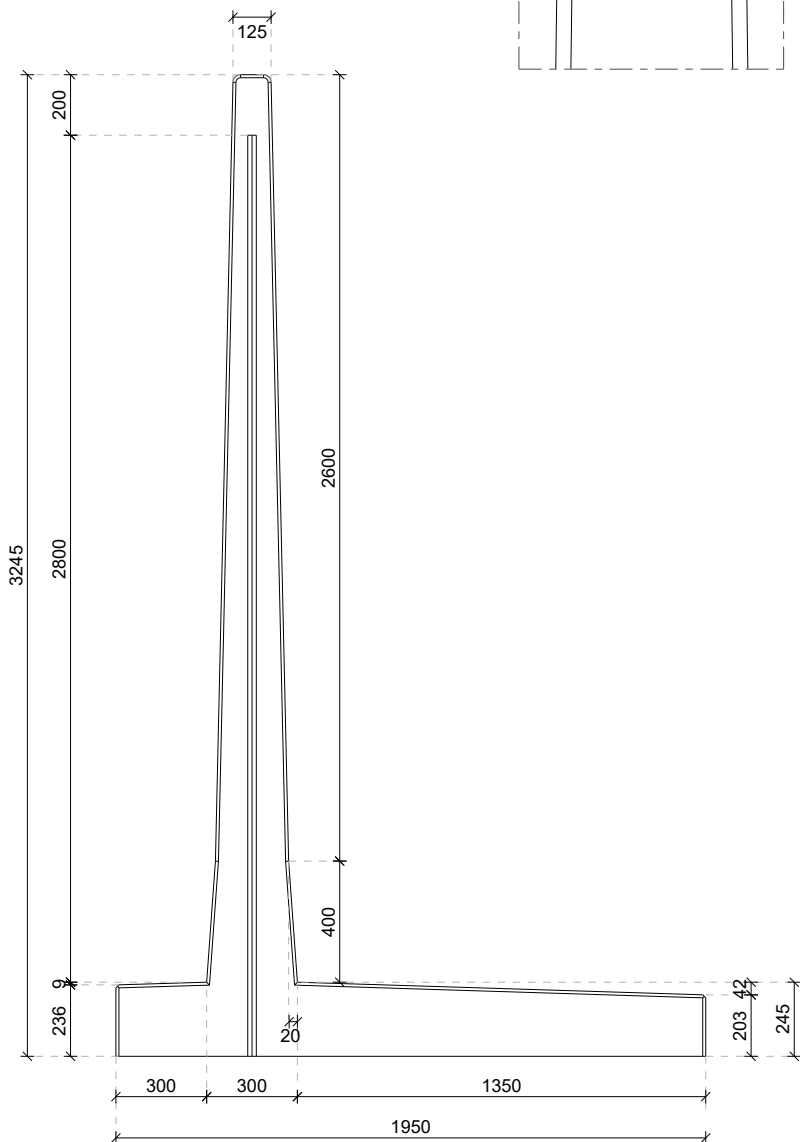

Details

Afgeronde bovenzijde

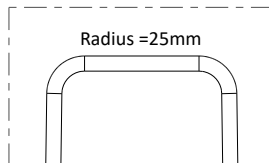

Koppellat-sparing

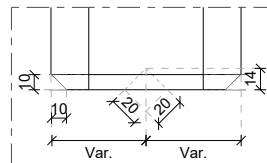

Verbindingselementen

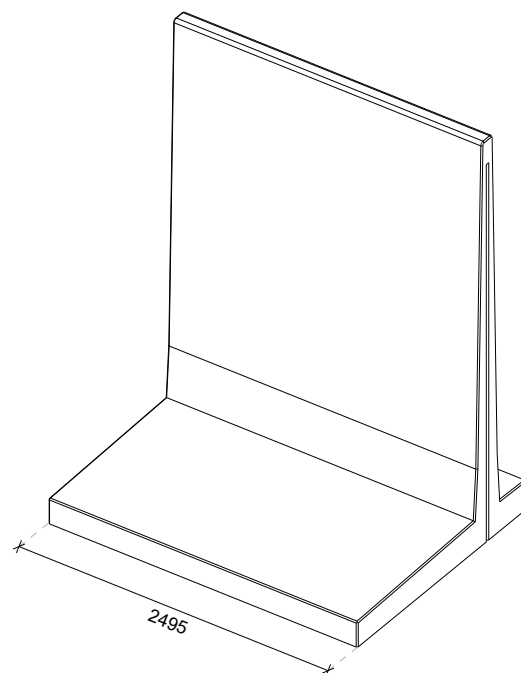
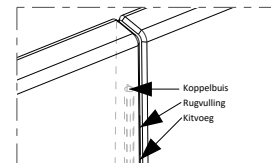

Technische details

| | |
|-------------------|--|
| Betonreceptuur | 2nd Generation self-compacting C60/75 |
| Wapeningsstaal | B500 |
| Gewicht | 6120kg (L=2495mm) |
| Betondekking | 30mm |
| Maattolerantie | +/-5mm |
| Zichtbetonklasse | Alle zichtzijdes glad bekist (Klasse A) |
| Hijsvoorziening | Geen, plaatsen met klem |
| Productgarantie | 10 jaar |
| Milieuklasse | XA3, XC4, XD3, XS3, XF4 |
| Ontwerplevensduur | 50 jaar(XA3, XD3, XS3) 100 jaar(XC4, XF4) |

Geconstrueerd conform

| | |
|------------------------|--------------------------|
| NBN-EN 1990 Eurocode 0 | NBN-EN 206 |
| NBN-EN 1991 Eurocode 1 | Incl. nationale bijlagen |
| NBN-EN 1992 Eurocode 2 | |
| NBN-EN 1997 Eurocode 7 | |

Productiewijze



Energie
neutraal



Gefilterd
hemelwater



Duurzame
grondstoffen



Recyclebare
materialen

Certificering

