

# TYPE LR200H

## Afmetingen

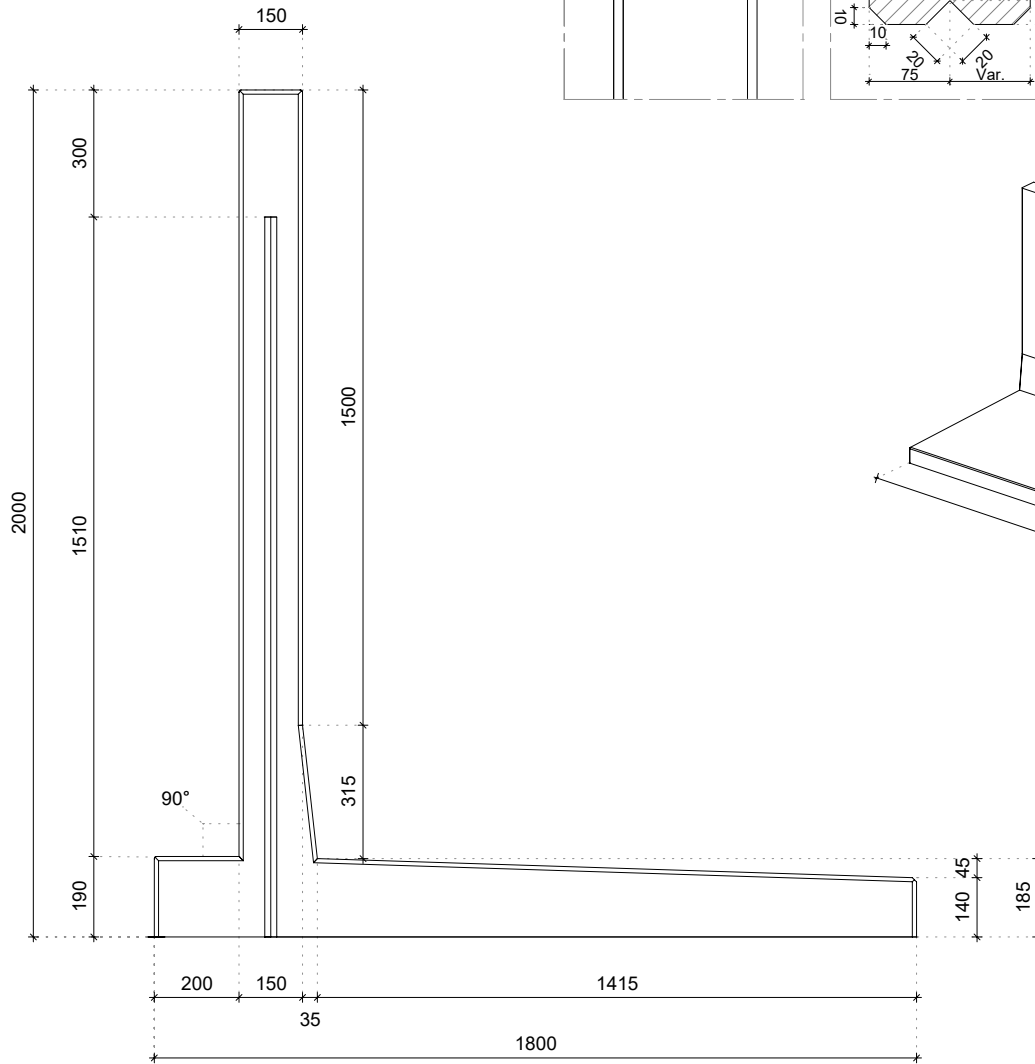

## Details

### Afgeronde bovenzijde

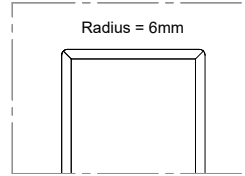

### Koppelat-sparing

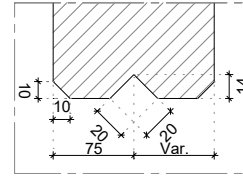

### Verbinding elementen

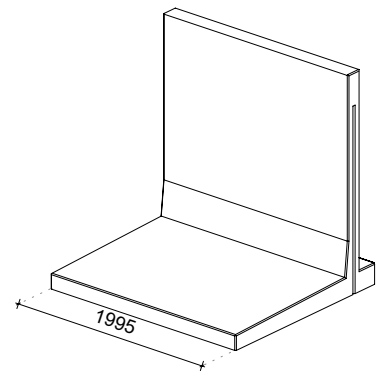
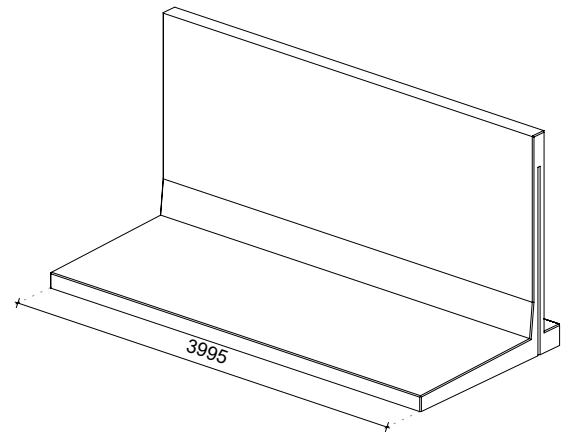
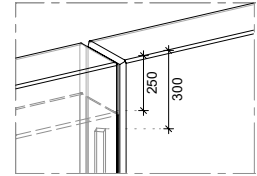

## Technische details

Betonreceptuur	2nd Generation self-compacting C60/75
Wapeningsstaal	B500
Gewicht	5646kg (L = 3995mm) / 2823kg (L = 1995mm)
Betondekking	45mm
Maattolerantie	+/- 5mm
Zichtbetonklasse	Alle zichtzijdes glad bekist (Klasse A)
Ontwerplevensduur	100 jaar
Productgarantie	10 jaar
Milieuklasse	XA3, XC4, XD3, XS3, XF4
Hijsvoorziening	Geen, plaatsen met klem

## Geconstrueerd conform

NBN-EN 1990 Eurocode 0	NBN-EN 206
NBN-EN 1991 Eurocode 1	Incl. nationale bijlagen
NBN-EN 1992 Eurocode 2	
NBN-EN 1997 Eurocode 7	

## Productiewijze



Energie  
neutraal



Gefilterd  
hemelwater



Duurzame  
grondstoffen



Recyclebare  
materialen

## Certificering

